

# Google SketchUp Design Project: Grades 1 - 5

*This project works in any version of SketchUp.*

The first thing kids this age like to do in SketchUp is make a basic house and try out different colors and materials. They also love making windows and doors, and trying out the translucent colors. This is the perfect project to get them started using SketchUp and get their creative juices flowing - by using just a few basic tools kids can quickly design a fun, colorful house. (And it won't take long for them to start designing much more complex ones!)

---

*If you need some basic information on downloading Google SketchUp, or about its user interface and basic tools, please see our printable "Intro to SketchUp" PDF.*

*The PC version is at [www.3dvinci.net/SketchUp\\_Intro\\_PC.pdf](http://www.3dvinci.net/SketchUp_Intro_PC.pdf).*

*The Mac version is at [www.3dvinci.net/SketchUp\\_Intro\\_MAC.pdf](http://www.3dvinci.net/SketchUp_Intro_MAC.pdf).*

---

1. Start with a **Rectangle**, and **Push/Pull** it up to a box.

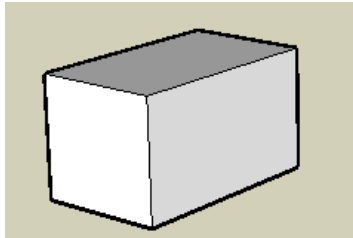

2. To make the roof, start with a line on the roof between midpoints.

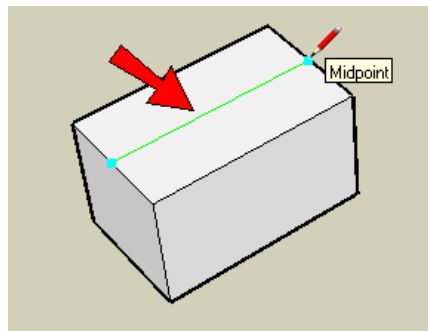

- Use **Move** on this line, pulling it up (in the blue direction) to make the roof.

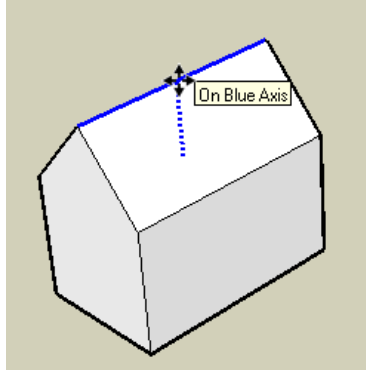

- Add a rectangle on the front face, to make a door.

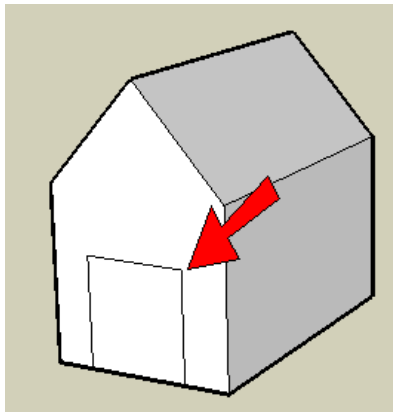

- To make a more interesting door, add an arc at the top (use the **Arc** tool).

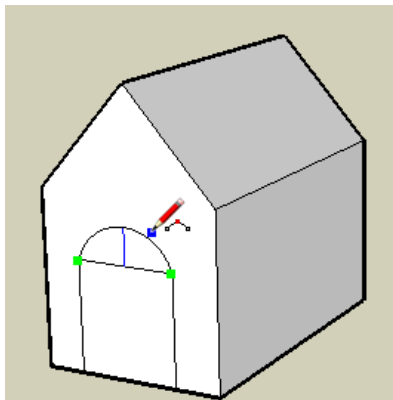

6. Use the **Eraser** tool to erase the top edge of the rectangle, so the door is one face.

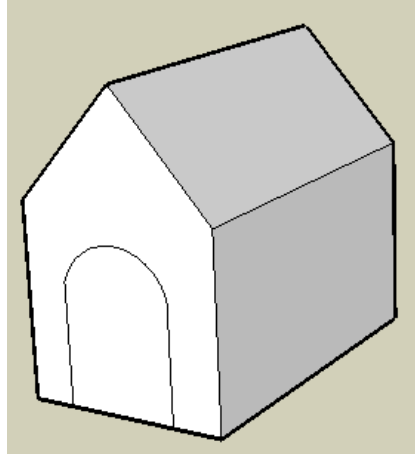

7. To remove the door face, right-click on it and choose **Erase**.

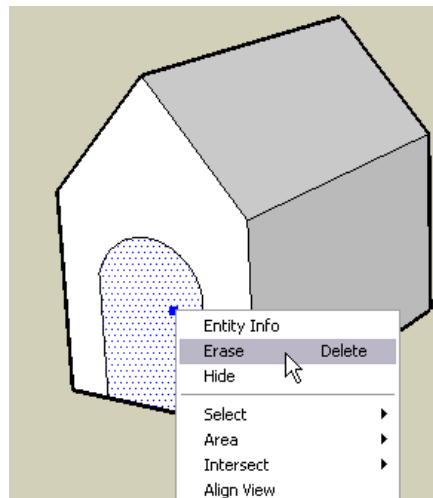

Now you can see into the house.

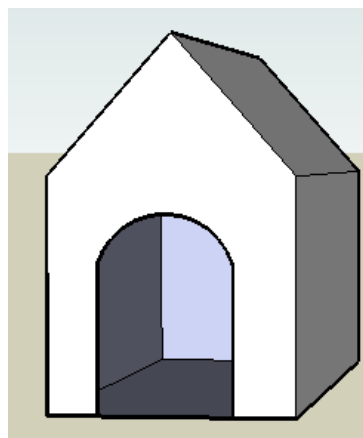

8. To make a window, add a rectangle on the side.

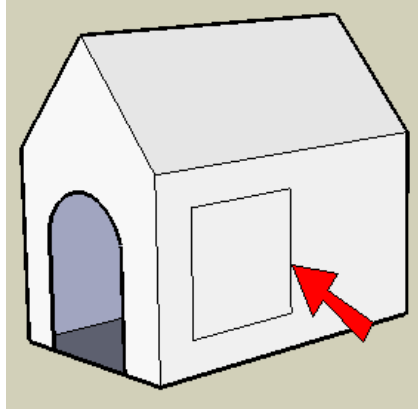

9. Of course, windows don't have to be rectangles! Use **Line** and make some strange shape for a window. Be sure that you see "On Face" while making lines, or the lines might end up sticking out of the house.

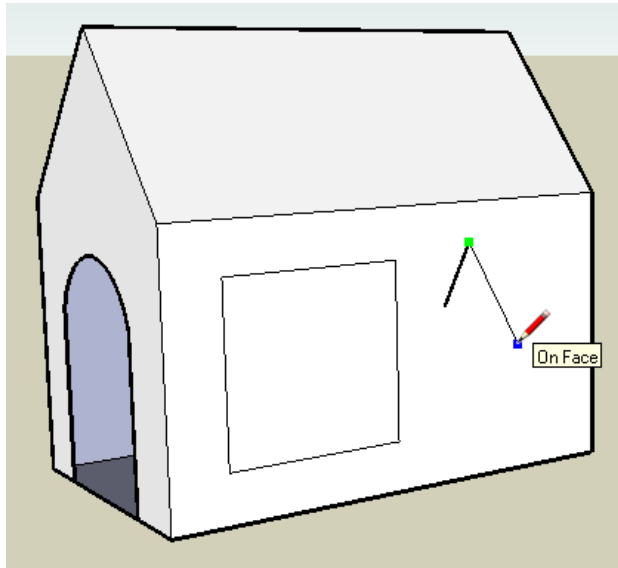

10. Be sure to end the window shape where you started. If your lines are correct, the edges around the window will be thin.

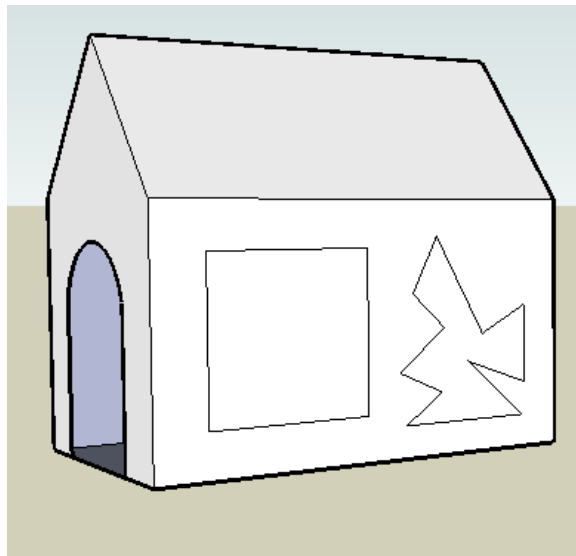

11. Now we can color our house, starting with the roof. Click the **Paint Bucket** tool to open the **Materials** window (**Colors** on the Mac). Open the “Roofing” folder and click one of the swatches (I’m using the red metal roof).

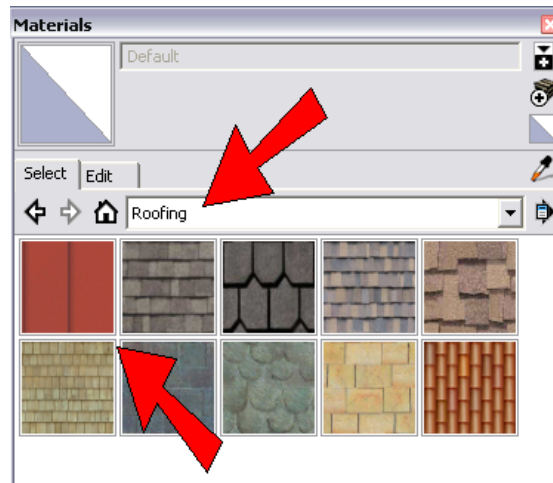

12. Then click the roof face (don't forget to paint both sides of the roof).

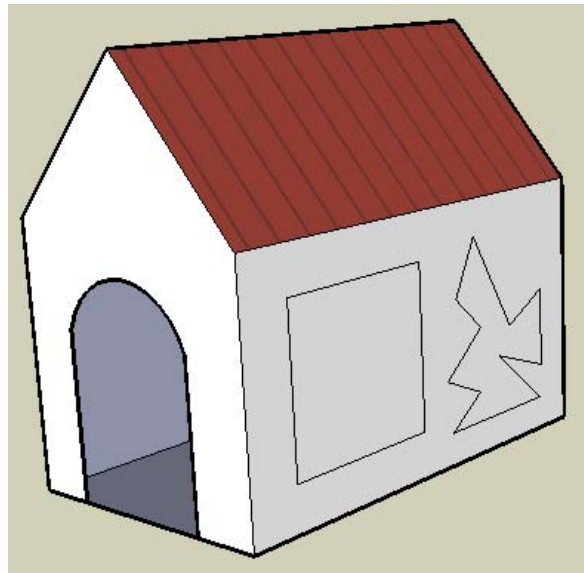

13. For the walls, I'm using tan bricks from the “Bricks and Cladding” folder.

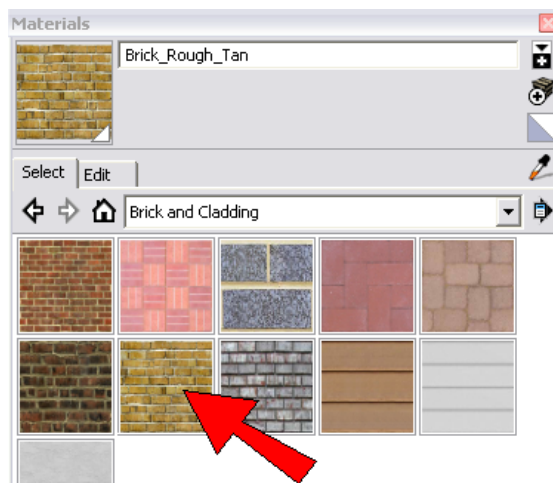

Here are the painted sides of the house:

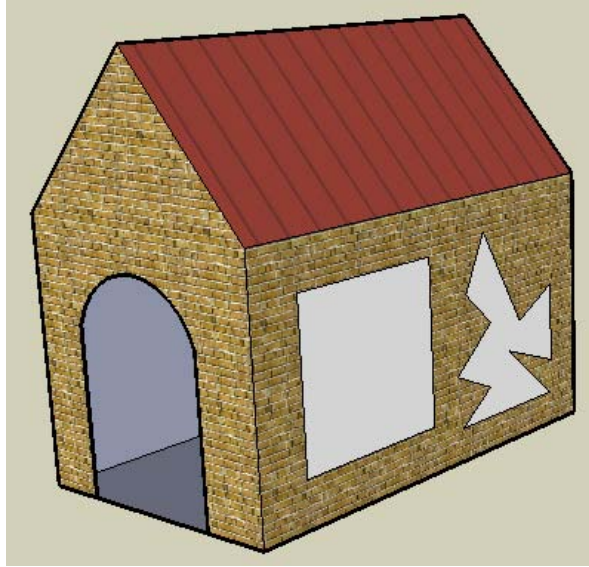

14. For the windows, you can use colors in the “Translucent” folder.

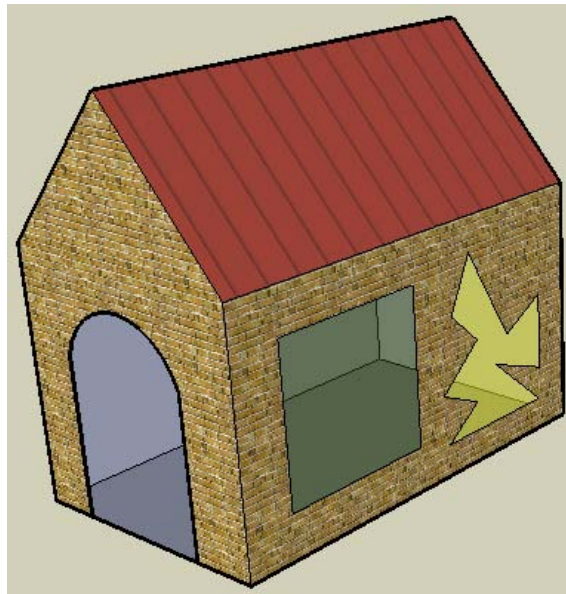

15. These windows are so plain - let's make them more interesting. Add some vertical stripes to this window:

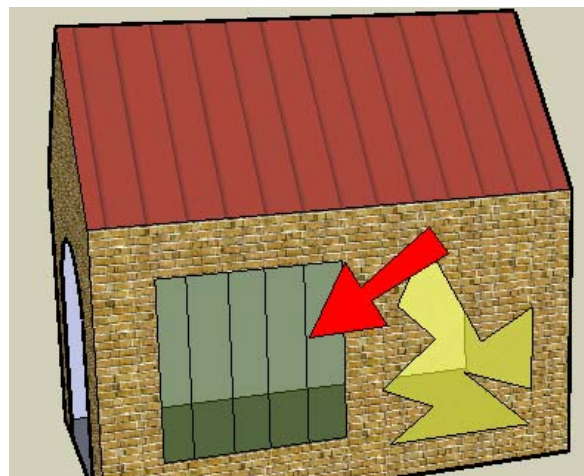

16. Then paint the stripes using different translucent colors.

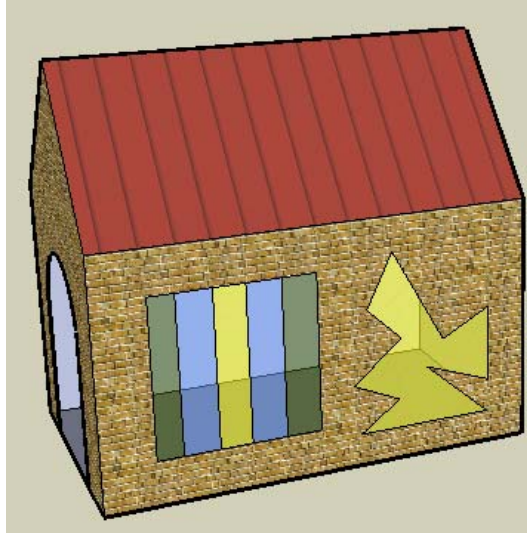

17. If you don't want people to see straight into your house, you probably want to replace that door. Just use **Line** to redraw any of its edges, and the face comes back.

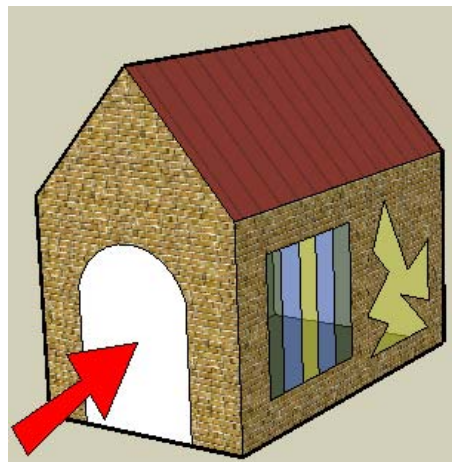

18. To dress up the door, you can add a circle for a window. I painted my door with cherry wood from the “Wood” folder.

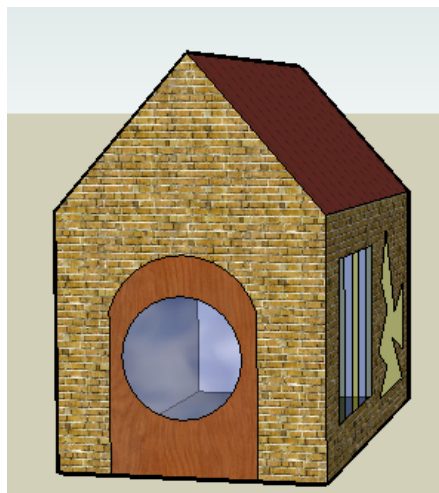

19. To personalize the house, you can add text using the **3D Text** tool (in the **Large Tool Set** toolbar or choose **Tools / 3D Text** from the main menu.)



3D Text requires that you enter a specific font and size, so you might have to try a few times to get the exact text you want. It also comes into the model as a component, so if you want to change it, you need to edit the component first (or explode the component).

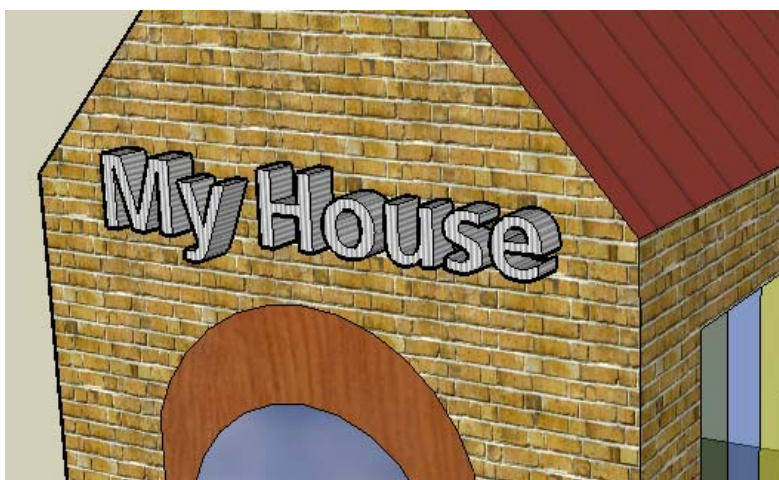

If you like this project, please check out 3DVinci's ModelMetrics Basics Series ([http://www.3dvinci.net/ccp0-prodshow/MBB\\_PDF.html](http://www.3dvinci.net/ccp0-prodshow/MBB_PDF.html)). These books will show you how to create basic objects such as houses and buildings, and provide a great introduction into groups and components.

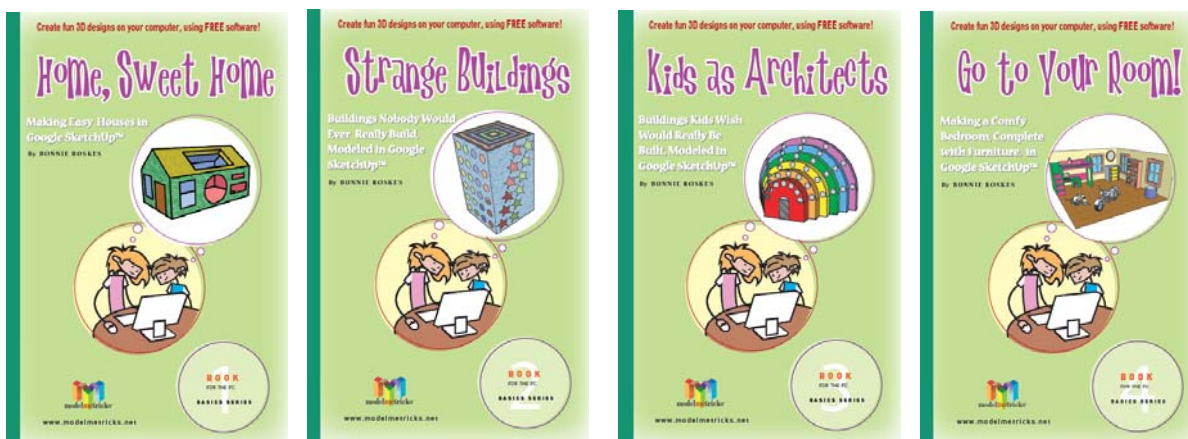

And if you want to receive three ready-to-use projects like these each month, sign up for our SketchUp Projects of the Month subscription (<http://www.3dvinci.net/ccp0-prodshow/POM.html>).